











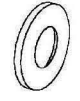

# Držák projektoru na krátkou projekci návod na montáž

## Seznam dílů

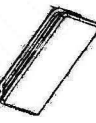
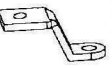
<b>A</b>  M8X60 (X5)	<b>B</b>  X1	<b>C</b>  S=5mm (X1)	<b>D</b>  PW6.2X13X1(X1)	<b>E</b>  M6X12 (X1)	<b>F</b>  M4X8 (X6)	<b>G</b>  M5X9 (X2)	<b>H</b>  M5X10 (X4)	<b>I</b>  S=3mm (X1)	<b>J</b>  X1
<b>K</b>  X2	<b>L</b>  M3X8 (X4)	<b>M</b>  PW3.2X10X1(X4)	<b>N</b>  S=2.5mm (X1)	<b>O</b>  X1	<b>P</b>  X1	<b>Q</b>  X1	<b>R</b>  X1	<b>S</b>  X1	

## Instalace

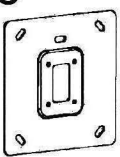
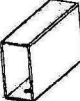
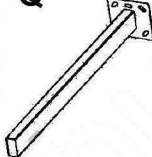
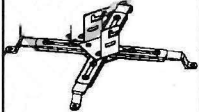
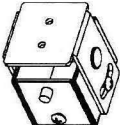

Tento držák na projektor na krátkou projekci se smí instalovat výlučně na cihlové nebo betonové zdi a jen s použitím výrobcem přiložených šroubů.

## Upozornění!

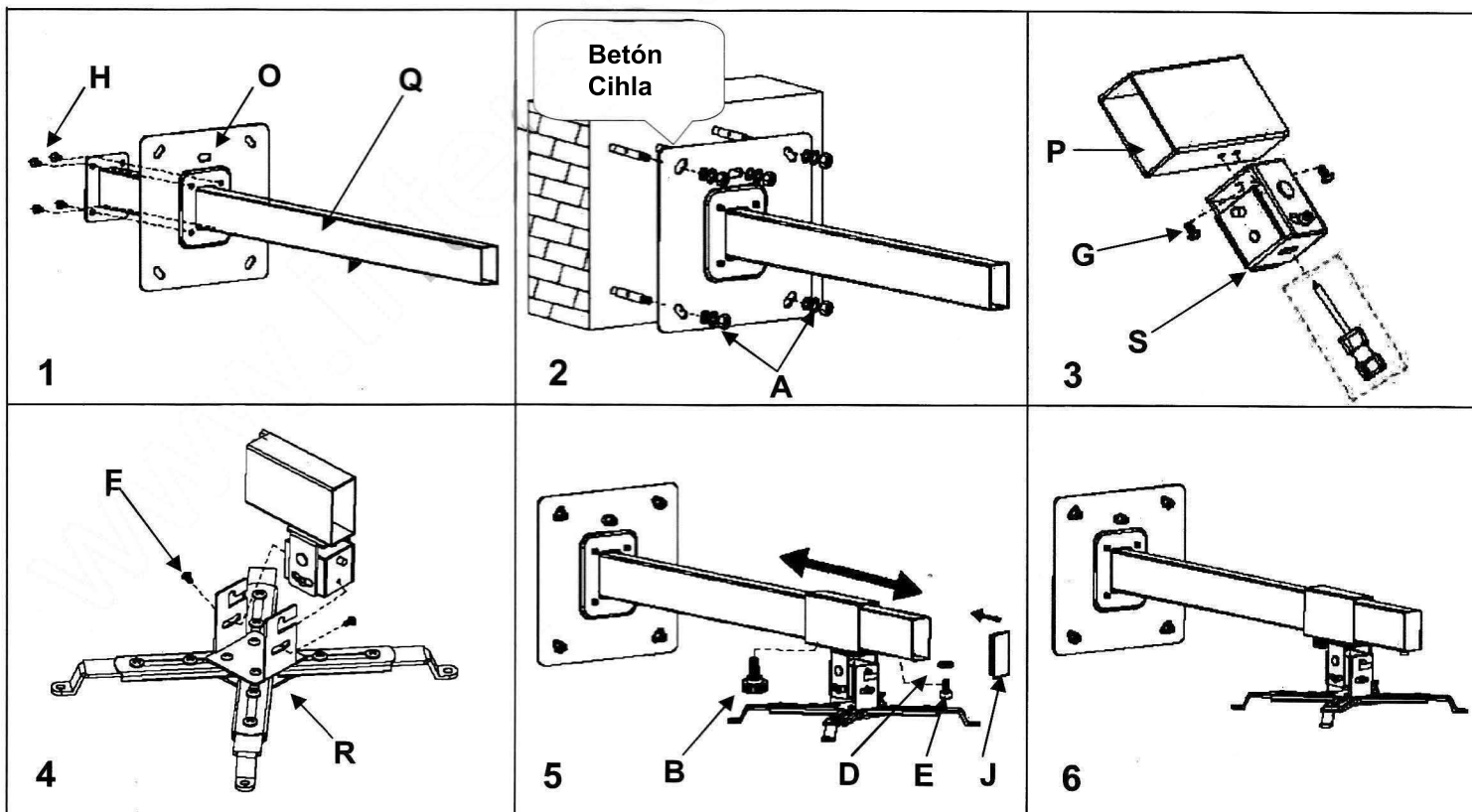

Pozn.: Při montáži projektoru Acer S1283Hne doporučujeme pro usnadnění montáže vyšroubovat gumové nožičky projektoru, převléci přes otvory (díl K) na růžici držáku a znovu zašroubovat. Nahradí tím pádem šrouby určené pro uchycení samotného projektoru (díl L). Tyto 3 nožičky projektor bez problémů udrží váhu projektoru a zrychlí samotnou montáž.